

Вид А

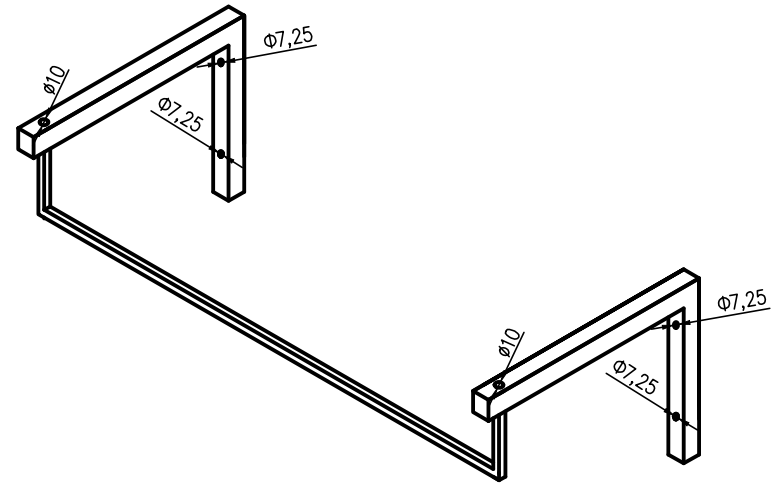
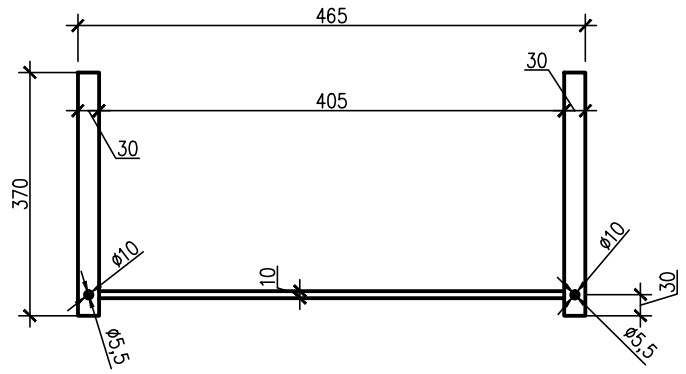

Изм.	Лист	№ док.	Подпись	Дата

Модель 6